



ZEISS Stemi 305

Compact Size, Big Impact: Your Stereo Microscope with Integrated Illumination and Documentation

zeiss.com/stemi305



Seeing beyond

All-in-one design. Easy to Use. Easy Documentation, too.

- › **In Brief**
- › The Advantages
- › The Applications
- › The System
- › Technology and Details
- › Service

Stemi 305 is your compact stereo microscope with a 5:1 zoom – equally at home in the biology classroom, research lab or on the industrial shop floor. Choose between predefined microscope sets to get the optimal illumination equipment for your applications. Stemi 305 lets you observe samples as they really are: three-dimensional and crisp in contrast – no preparation needed. Enjoy all the advantages of an easy-to-use microscope with integrated LED illumination for reflected and transmitted light – plus fast, easy-to-use documentation. Just snap your images with the integrated 4 Megapixel Wi-Fi/Ethernet camera and share them using Labscope. Or choose the conventional phototube for access to all ZEISS Axiocam cameras and free ZEN lite imaging software. This Greenough microscope will give you crisp 3D impressions, versatile object illumination and easily acquired images to share, whenever you want.



Simpler. More Intelligent. More Integrated.

- › In Brief
- › **The Advantages**
- › The Applications
- › The System
- › Technology and Details
- › Service

More than Design. All-in-One Device.

It's compact and it's fun. Yet Stemi 305 integrates everything you need into a single Greenough stereo microscope. Just plug it in and switch it on – that's the installation done, with no extra accessory boxes or cables to clutter up your space. Then all you have to do is illuminate your object, focus and start snapping images.

Use Stemi 305 cam with on-board Wi-Fi/Ethernet camera to easily save your results, share them and collaborate on projects with friends, colleagues and classmates. Store Stemi 305 away when work is done, then take it out and get started again in minutes.

Illumination. Crisp for Any Application.

Despite its ease of use, Stemi 305's integrated illumination is variable to contrast every specimen at its best. Simply press a button to select and combine up to two reflected light contrasts and transmitted light. While each zoom body is equipped with near-vertical light to illuminate deepenings in the sample, the second reflected light and transmitted light units are interchangeable. This enables predefined microscope sets for education, laboratory or industrial use to optimize contrast in your application range. White LEDs in your Stemi 305 generate the brightlight of daylight color so each image appears crisp and clear. What's more, long-life LEDs are noiseless, maintenance-free – and real energy savers.

Documentation. Integrated and Wireless.

Documentation is important for lab work, essential for industrial inspection. In the classroom your ability to acquire and share images is a key resource for vivid, exciting science courses. Stemi 305 comes with two options for documentation. Choose Stemi 305 trino with a conventional phototube for access to any ZEISS Axiocam microscope camera and free ZEN lite imaging software. Or go for Stemi 305 cam with its integrated Wi-Fi/Ethernet camera. Create your own virtual classroom by using Labscope, to stream live images from several microscopes to all connected mobile devices. It's easy to share, compare and discuss the work of all the students on your own wireless network. Fun, too.



Your Insight into the Technology Behind It

- › In Brief
- › **The Advantages**
- › The Applications
- › The System
- › Technology and Details
- › Service

ZEISS Stemi 305 for Education **Easy to Transport. Easy to Install.** **Easy to Use.**

In an academic environment you often have to stow away your systems and just as often set them up again. Storage space is limited. And you work with untrained or changing users. That's why you need a compact stereo microscope that's quick to (de)install and easy to shift – ideally, without extra boxes to cart around or accessories to lose. And of course the microscope must be reliable, robust and easy to use, even if the manual is long gone – and also feature quality optics and those all-important illumination contrasts.

That's a tall order, and precisely why you need the Stemi 305 education set. It has a small footprint and comes with a flat stand base and carrying handle. LED illuminations and power supply are integrated. It's easy to select and combine two reflected light illuminations and transmitted light. Stemi 305 education set provides a near-vertical illuminator to observe holes and cavities, and an oblique light spot. Just plug Stemi 305 in and play.

For a digital classroom environment use Stemi 305 cam with stand K EDU and spot K LED.



Compact and optimized for education use.



Easily switch between vertical illumination, oblique spot or mixed light by the push of a button – and adjust their intensities.



Change height of the spot and zoom in to create distinct shadows for a strong 3D impression. In the lowest position it delivers a grazing light that enhances fine structures on flat surfaces via hard shadows.



Use the flat transmitted light unit to contrast colored transparent specimens in bright- and darkfield. Add polarizer/analyzer equipment to observe, for example, birefringent crystals or tensions in glass or plastics.

Your Insight into the Technology Behind It

- › In Brief
- › **The Advantages**
- › The Applications
- › The System
- › Technology and Details
- › Service

ZEISS Stemi 305 for Laboratory Versatile Illumination for Sample Preparation

Workspace is always limited in a laboratory where you are observing, preparing or dissecting model organisms and other bio specimens. You may be looking at oocytes or embryos, larvae or adult animals, or at plant components such as roots and leaves. For all these reasons you need variable contrasting methods in transmitted light, but also reflected light. Use the mirror-based transmitted light unit of stand K LAB to observe and manipulate even uncolored transparent specimens. With stand K LAB reflected and transmitted light can be selected easily or combined. To document your results choose Stemi 305 cam or Stemi 305 trino with stand K LAB, double spot K and ergonomic hand rest.



Compact, versatile and well prepared for laboratory work.



The tiltable and shiftable mirror features brightfield, one-sided darkfield and oblique light – plus polarization contrast as an option. Rotate to frosted and plain mirror side, then decide between crisp and diffuse brightfield contrast.



For sample preparations in reflected light, the double spot illumination with self-carrying goosenecks is optimal. It creates half-shadow effects that lead to a good 3D impression without overly dark shadows. During dissections the specimen stays illuminated even if the manipulating hand covers one of the spots.

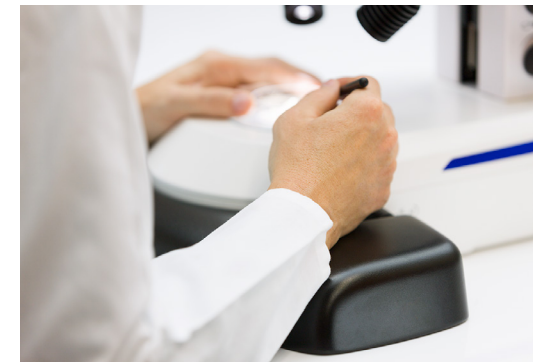

For extended work add the ergonomic hand rest to keep your hands relaxed, even during long preparations.

Your Insight into the Technology Behind It

- › In Brief
- › **The Advantages**
- › The Applications
- › The System
- › Technology and Details
- › Service

ZEISS Stemi 305 for Industry Segmentable Ringlight for Quick Inspections

Stereo microscopes are essential to everyday routines in your production line or quality department: inspecting, assembling or repairing electronic or optoelectronic components, small mechanical parts, sensors or measuring devices. And if you work in electronic industries your microscopes operate in electrostatic protected areas (EPAs). Choose Stemi 305 MAT for visual inspection or small parts assembly. It provides stand K MAT with reflected light LED controls and anti-static surface resistance to enable use in EPAs. It also includes two reflected light illuminations: the integrated vertical illuminator to look at holes, threads and cavities – and the segmentable ringlight K LED. Simply press the dimming button at the side of the focus column to switch quickly between vertical spot, ring illumination and mixed light. To document or archive your results use Stemi 305 trino with stand K MAT and segmentable ringlight K.



Compact, easy to use and suited for electrostatic protected areas.



Stemi 305 is equipped with an integrated near-vertical LED spot to illuminate holes and indentations – even through front optics.



The shadow-free ringlight features four different segment modes: full-, half- and quarter-circle and 2-opposite quarter-circle. Set the segment illumination, then turn the light direction manually in 90° steps to quickly inspect for scratches, defects or residues without moving your specimen. Or use auto rotating mode to get a spatial impression of the object surface just by changing shadows.

Your Insight into the Technology Behind It

- › In Brief
- › **The Advantages**
- › The Applications
- › The System
- › Technology and Details
- › Service

Document Your Results. Archive and Share.

ZEISS Stemi 305 trino



Enjoy the flexibility of Stemi 305 trino with access to ZEISS Axiocam microscope cameras and ZEN imaging software. The fixed 50/50 division between left eye and camera path is optimal for live demonstrations: your students or customers can follow your microscopic work live on the monitor. Combine Stemi 305 trino with Axiocam 208 color and get the advantage of various interfaces: HDMI for direct monitor access, USB to use with Windows PC and free ZEN lite imaging software, or LAN to connect to a digital network and control the camera with Labscope.

ZEISS Stemi 305 cam



Stemi 305 cam is your compact and easy-to-use solution for educational tasks. The fast, color Wi-Fi/Ethernet camera has already been integrated into the microscope body. In "WLAN access point" mode each Stemi 305 cam creates its own WLAN: up to 12 mobile devices can connect directly to the integrated camera and display its live image using Labscope. To create a high quality digital classroom, enable "Connect to existing WLAN" mode and connect several Stemi 305 cams to the same digital network. Your students can then share their microscope images and collaborate on projects with colleagues and classmates. Let them learn the fun way.

ZEISS Labscope



ZEISS Labscope displays the live images of all Stemi 305 microscopes in your network to each connected mobile device. With one touch you can look at each student's results. It's easy to snap an image, add annotations and measurements, and save it – or export it directly to your server. Once connected to the internet you can share your images, reports or videos with others via email, social media or cloud services. With Labscope, you are saving your images in the ZEN compatible .czi file format including all metadata – or you can select the space-saving .jpg format.

Expand Your Possibilities

- › In Brief
- › **The Advantages**
- › The Applications
- › The System
- › Technology and Details
- › Service



Choose from a range of interchangeable front optics and eyepieces – and get access to all magnifications between 4x and 200x, double resolution of your Stemi 305 or maximize free working distance and object field.



For demanding samples such as dark specimens, special contrast techniques or critical color evaluations, you will need the separate cold light source CL6000 LED. Enjoy the benefits of its high color rendering index 90 and a large range of fiber optic light guides and accessories. For stands without LED electronics chose between compact stand K or large stand N.



To observe big specimens or to cover a large area of interest, choose from our range of boom stands: stand A with its single extension arm, ball-bearing boom stand SDA for extra stability and easy movement, or tilting arm stand U, well balanced in height to cover large specimen volume. Add the front lens 0.5x to profit from 185 mm working distance.



To position your specimen precisely, use a ball-and-socket, gliding or rotating polarization stage.



Use stand K (version without electronics) and adapt articulating arms to finely adjust light guides.



Controller K powers the integrated Wi-Fi camera, the vertical illuminator or the segmentable ringlight when Stemi 305 is used with boom stands.

Expand Your Possibilities

- › In Brief
- › **The Advantages**
- › The Applications
- › The System
- › Technology and Details
- › Service

Document and archive your results.

And share the images in your digital network.
It is full of possibilities.

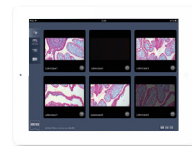

In the "WLAN access point" mode each Stemi 305 cam creates its own Wi-Fi net. Up to 12 mobile devices can connect to it, display its live image and control the integrated camera.

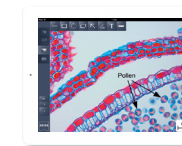
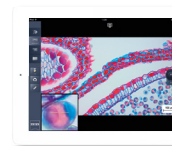
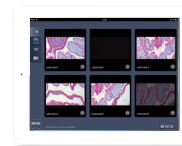

To set up your digital classroom network, switch all Stemi 305 cams to "Connect to existing WLAN" mode. Then connect them to the same Wi-Fi net provided by your external WLAN router. Further ZEISS microscopes or Axiocam cameras may also be connected via a LAN interface. Labscope can then stream the live images of all microscopes to each iPad in the net. It's easy to snap and edit images – and archive them on your local server.

Tailored Precisely to Your Applications

- › In Brief
- › The Advantages
- › **The Applications**
- › The System
- › Technology and Details
- › Service

Typical Applications, Typical Samples	Task	ZEISS Stemi 305 Offers
Education Lab Courses and Advanced Training in:	Study and identify various kinds of unprepared specimen during academic lessons and lab courses.	<ul style="list-style-type: none"> ■ Compact education microscope set including Stemi 305 stereo microscope with 5:1 zoom, compact stand and integrated illumination for reflected and transmitted light. ■ All-in-one design, easy to carry, easy to install and easy to use. ■ Various illumination techniques integrated: Reflected light spot for oblique light. Near vertical spot to illuminate deepenings. Flat transmitted light unit for brightfield and darkfield. ■ Optional equipment for qualitative transmitted light polarization.
<ul style="list-style-type: none"> ■ Botany 	Investigate the morphology of plant organs.	
<ul style="list-style-type: none"> ■ Zoology 	Study the anatomy of small animals such as worms, snails, spiders, frogs, mice.	
<ul style="list-style-type: none"> ■ Mineralogy 	Study composition and structure of minerals and rocks.	
<ul style="list-style-type: none"> ■ Geology 	Collect and identify micro fossils, such as foraminifera.	
Live Demonstrations	Teach sample preparation or dissection on large screen while the whole class is observing your work.	<ul style="list-style-type: none"> ■ Using Stemi 305 trino with Axiocam 208 color you simultaneously work under the stereo microscope while the live window is displayed on a large HDMI monitor or beamer.
Digital Classroom	Connect all microscopes in the classroom and share their live images. Snap, edit and discuss your results easily.	<ul style="list-style-type: none"> ■ Connect several Stemi 305 cam with integrated Wi-Fi/Ethernet cameras to your network. Use free Labscope to display all live images on each iPad in the net.
Laboratory Routine Laboratory Work in Bio Labs	Screen, sort and prepare your plants, animals, embryos, eggs or larvae. Observe, manipulate and dissect model organisms such as <i>Drosophila</i> , <i>C Elegans</i> , <i>Xenopus</i> or zebrafish. Document your results easily.	<ul style="list-style-type: none"> ■ Stemi 305 laboratory microscope set with mirror based transmitted light unit delivers crisp or homogeneous brightfield, darkfield and oblique light contrast. The latter is needed to contrast uncolored specimen such as <i>C Elegans</i>. For dissections in reflected light, a double spot gooseneck is integrated. ■ Document highly resolved images using Stemi 305 trino with a ZEISS Axiocam microscope camera.
Veterinary Medicine	Look for and identify parasites such as mites, ticks, fleas, and lice, as well as their eggs and larvae. Carry out small animal surgery. Collect and classify horse or cattle embryos for subsequent transfer or for deep freezing for breeding purposes.	<ul style="list-style-type: none"> ■ Use Stemi 305 with front lens 0.5x to get a long working distance and flexible tilting arm stand U. The near vertical based illumination of Stemi 305 is shadow free and homogeneous – and always correctly adjusted to the object field. ■ Stand K LAB delivers the oblique light contrast required to evaluate the embryos.

Tailored Precisely to Your Applications

- › In Brief
- › The Advantages
- › **The Applications**
- › The System
- › Technology and Details
- › Service

Typical Applications, Typical Samples	Task	ZEISS Stemi 305 Offers
Industry	Use Stemi 305 for assembly, visual inspection, and repair of various 3D shaped industrial work pieces.	<ul style="list-style-type: none"> ■ Compact Stemi 305 MAT microscope set includes integrated vertical illumination to illuminate holes and deepenings, and a shadow free ringlight. ■ ESD safe by antistatic surface treatment, usable in electrostatic protected areas. ■ The ringlight is segmentable for distinct shadow effects. Quickly change the light direction to find scratches and defects without moving the specimen. ■ To investigate structures of flat surfaces set double arm gooseneck to a low position to create grazing light. To reduce reflections from shiny parts add optional polarization equipment. ■ For large part inspection use cost effective boom stand A in combination with front lens 0.5x. Benefit from the integrated vertical illumination of Stemi 305. ■ To document with highly resolved images use Stemi 305 trino with Axiocam microscope camera. ■ Get the lowest cost imaging from Stemi 305 cam with integrated camera and iPad solution. The images can be archived easily to your local server via wireless LAN.
<ul style="list-style-type: none"> ■ PCB Electronics 	Visual inspection for damage to circuit boards, e.g. oxidation, stress corrosion, inaccurate drill holes.	
<ul style="list-style-type: none"> ■ Entertainment Electronics 	Inspection of the quality of soldered connections, e.g. for improper wiring or for damaged or missing components.	
<ul style="list-style-type: none"> ■ Micro Technology 	Manufacturing, inspection and repair of thick film or hybrid circuits.	
<ul style="list-style-type: none"> ■ Car Industry 	Inspection of injection nozzles, air bags ABS systems. Inspection of large parts, motor or chassis components.	
<ul style="list-style-type: none"> ■ Dental Laboratory 	Finish all-ceramic crowns accurately and reliably, identify and remove casting beads precisely in the framework.	<ul style="list-style-type: none"> ■ Use Stemi 305 flexible tilting arm stand U to share your microscope with two or three work places. The integrated vertical illumination of Stemi 305 is shadow free and homogeneous – and always correctly adjusted to the object field.

ZEISS Stemi 305 at Work

- › In Brief
- › The Advantages
- › **The Applications**
- › The System
- › Technology and Details
- › Service

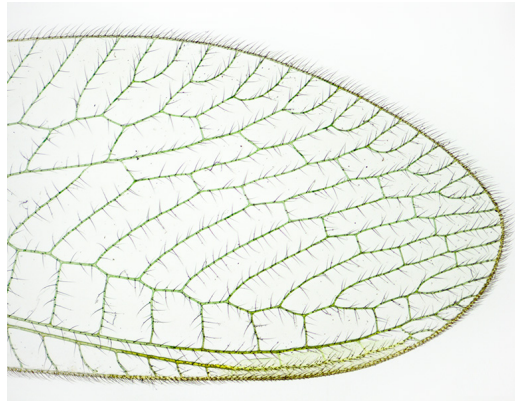

Wing of Chrisopidae; transmitted light brightfield

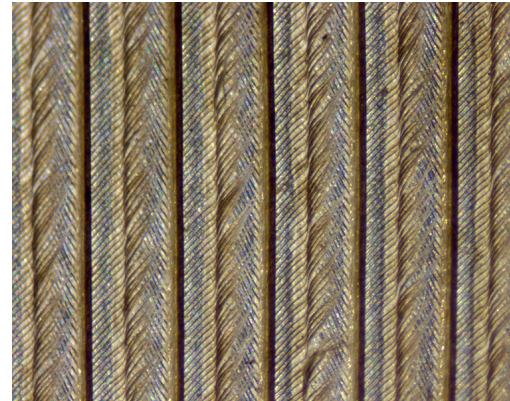

Feather of hawk; transmitted light brightfield



Grape ivi, appressoria; spot K LED oblique light, zoom 1.2x

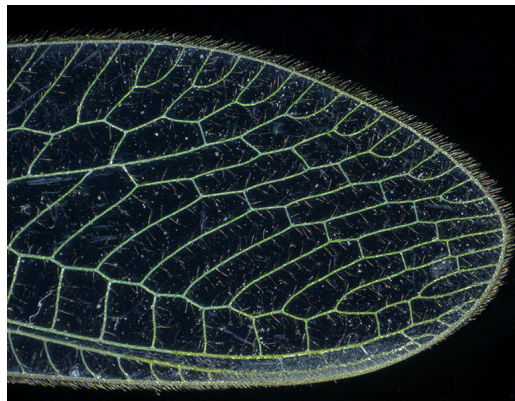

Wing of Chrisopidae; transmitted light darkfield



Royal fern, sori and sporangia; spot K LED, oblique light, zoom 2.0x



Aphid; spot K LED, oblique light, zoom 3.0x

ZEISS Stemi 305 at Work

- › In Brief
- › The Advantages
- › **The Applications**
- › The System
- › Technology and Details
- › Service

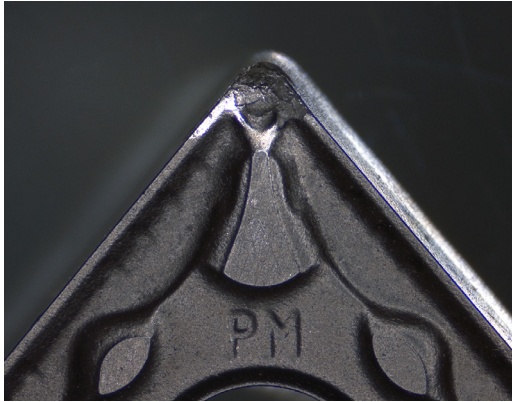

Indexable insert; ringlight full circle, zoom 0.8x

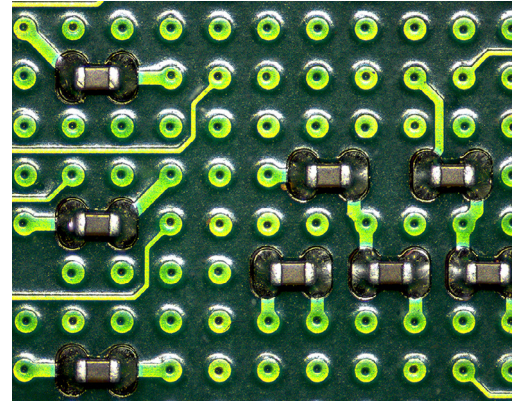

Printed circuit board; ringlight quarter circle, zoom 1.5x, front optics 0.75x

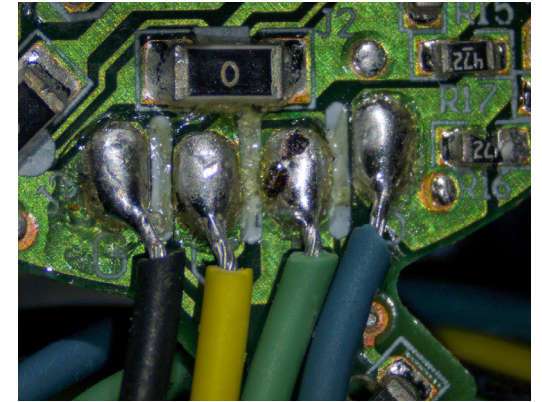

Hand soldered joints; ringlight, full circle

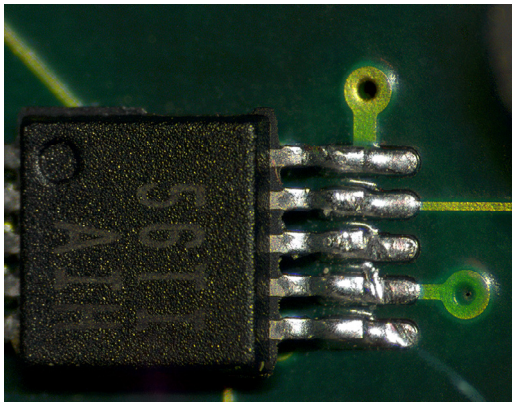

Damaged solder contact; ringlight quarter circle, zoom 3.5x, front optics 0.75x

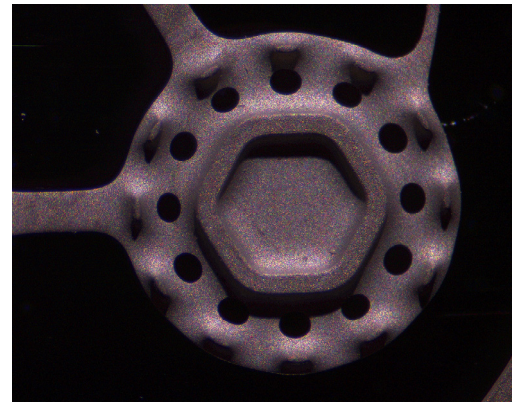

Automotive component; spot K LED, oblique light, zoom 1.5x, front optics 0.75x

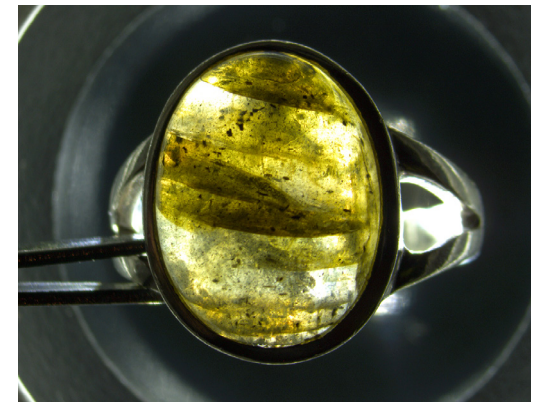

Ring with Labradorit; transmitted light darkfield

Your Flexible Choice of Components

- › In Brief
- › The Advantages
- › The Applications
- › **The System**
- › Technology and Details
- › Service

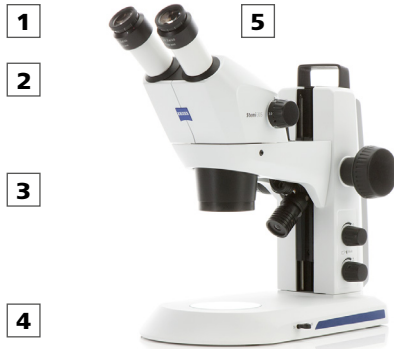

1 Microscope

- Stemi 305 (binocular)
- Stemi 305 trino (phototube, 50/50 division to the left, integrated c-mount camera adapter 0.5x)
- Stemi 305 cam (integrated 4 Megapixel Wi-Fi/Ethernet camera)

Microscope Sets

- Stemi 305 EDU
- Stemi 305 LAB
- Stemi 305 MAT

2 Interchangeable Optics

- Eyepieces: 10x/23 Br. Foc (included), 16x/14 Br. Foc, 25x/10 Foc
- Front optics: 0.5x, 0.75x, 1.5x, 2.0x



3 Illumination

- LED illuminators to stands K: spot, double spot gooseneck, segmentable ringlight, flat or mirror-based transmitted light stands
- Controller K – for standalone use integrated camera, near vertical spot or ringlight K
- Fiberoptic cold light sources CL6000 LED and CL1500 Hal with spot, annular ring, linear, vertical, diffuse and area illuminators, fiber optic transmitted light unit
- Polarization equipment for filters for spots, ringlights and transmitted light units

Illumination Techniques

- Reflected and transmitted light: brightfield; darkfield; polarization; oblique light

4 Stands

- Space saving table top stand K
- Stand K EDU with reflected light (=RL) LED electronics and flat transmitted light unit



- Stand K LAB with RL LED electronics and mirror-based transmitted light unit
- Stand K MAT with RL LED electronics and ESD features (antistatic)
- Large table top stand N
- Boom stands A and SDA, tilting arm stand U

5 Accessories

- Eyepiece reticles, gliding, ball/socket and rotating stages, ergo hand rest for stand K LAB

6 Software

- ZEN lite imaging software
- Labscope imaging app

7 Recommended Cameras

- Axiocam 105 color R2
- Axiocam 208 color
- Axiocam 305 color R2

Your Flexible Choice of Components

- › In Brief
- › The Advantages
- › The Applications
- › **The System**
- › Technology and Details
- › Service

Microscope Sets for: Education



- Binocular tube
- Integrated near vertical illumination
- LED spot, zoomable and height-adjustable, for oblique and grazing light illumination with strong shadow
- Flat transmitted light base for brightfield and darkfield illumination
- Optional: polarization equipment for spot and transmitted light
- Order number: 435063-9010-100

Laboratory



- Binocular tube
- Integrated near vertical illumination
- Double arm gooseneck, self-carrying, for variable oblique light illumination with distinct shadow effect
- Tiltable mirror base for brightfield, darkfield and oblique light illumination
- Optional: ergonomic hand rest, polarization equipment for spots and transmitted light
- Order number: 435063-9020-100

Industry



- Binocular tube
- Integrated near vertical illumination
- LED segmentable ring light for shadow free ring illumination and oblique light segment illumination: half circle, quarter circle, two-spot
- Rotating illuminating segments
- ESD properties: antistatic coating of microscope body and stand
- Order number: 435063-9030-100

System Overview

- › In Brief
- › The Advantages
- › The Applications
- › **The System**
- › Technology and Details
- › Service

Stemi 305 - Microscope Bodies, Optics, LED Stands K/M

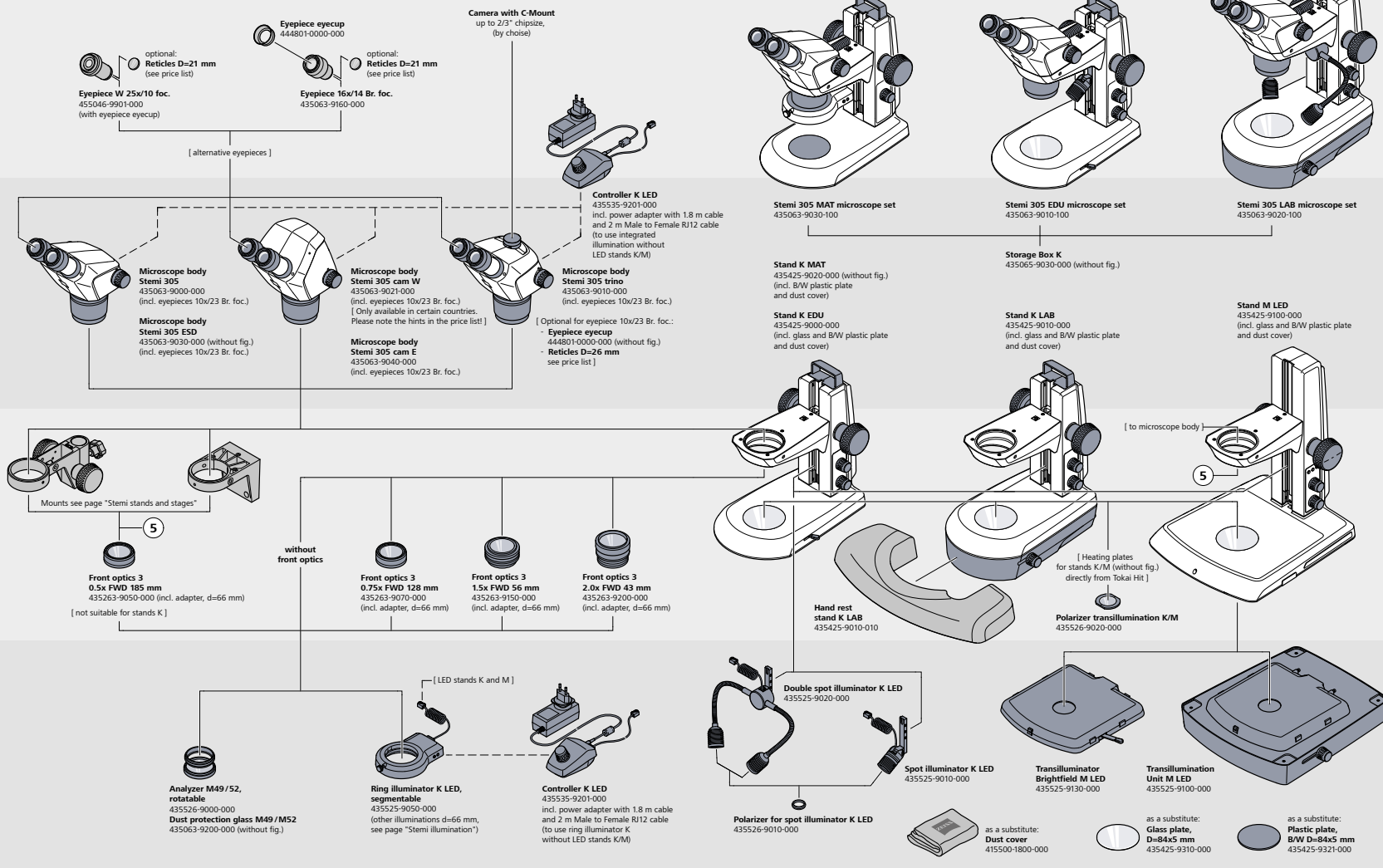

System Overview

- › In Brief
- › The Advantages
- › The Applications
- › **The System**
- › Technology and Details
- › Service

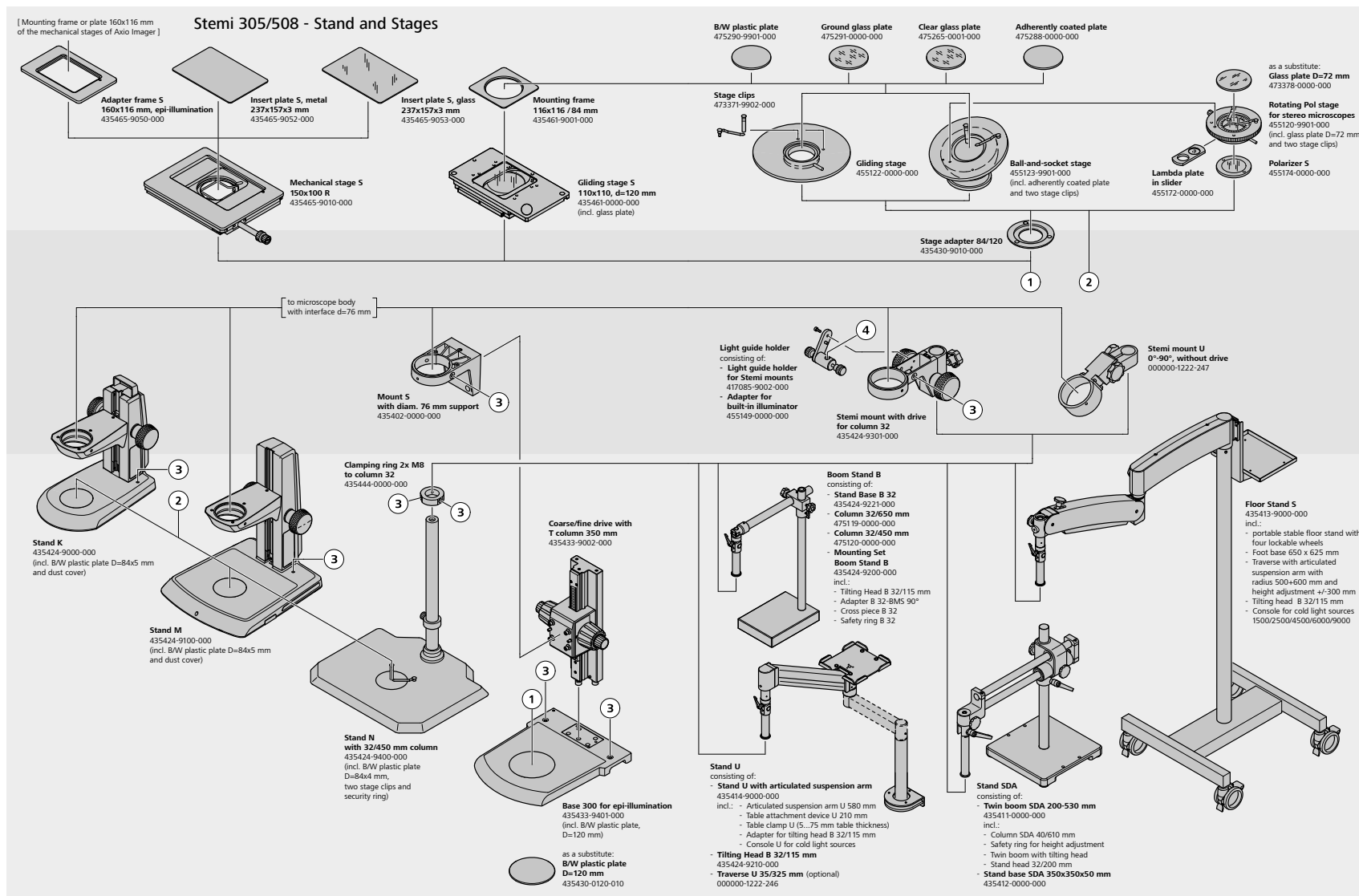

System Overview

- › In Brief
- › The Advantages
- › The Applications
- › **The System**
- › Technology and Details
- › Service

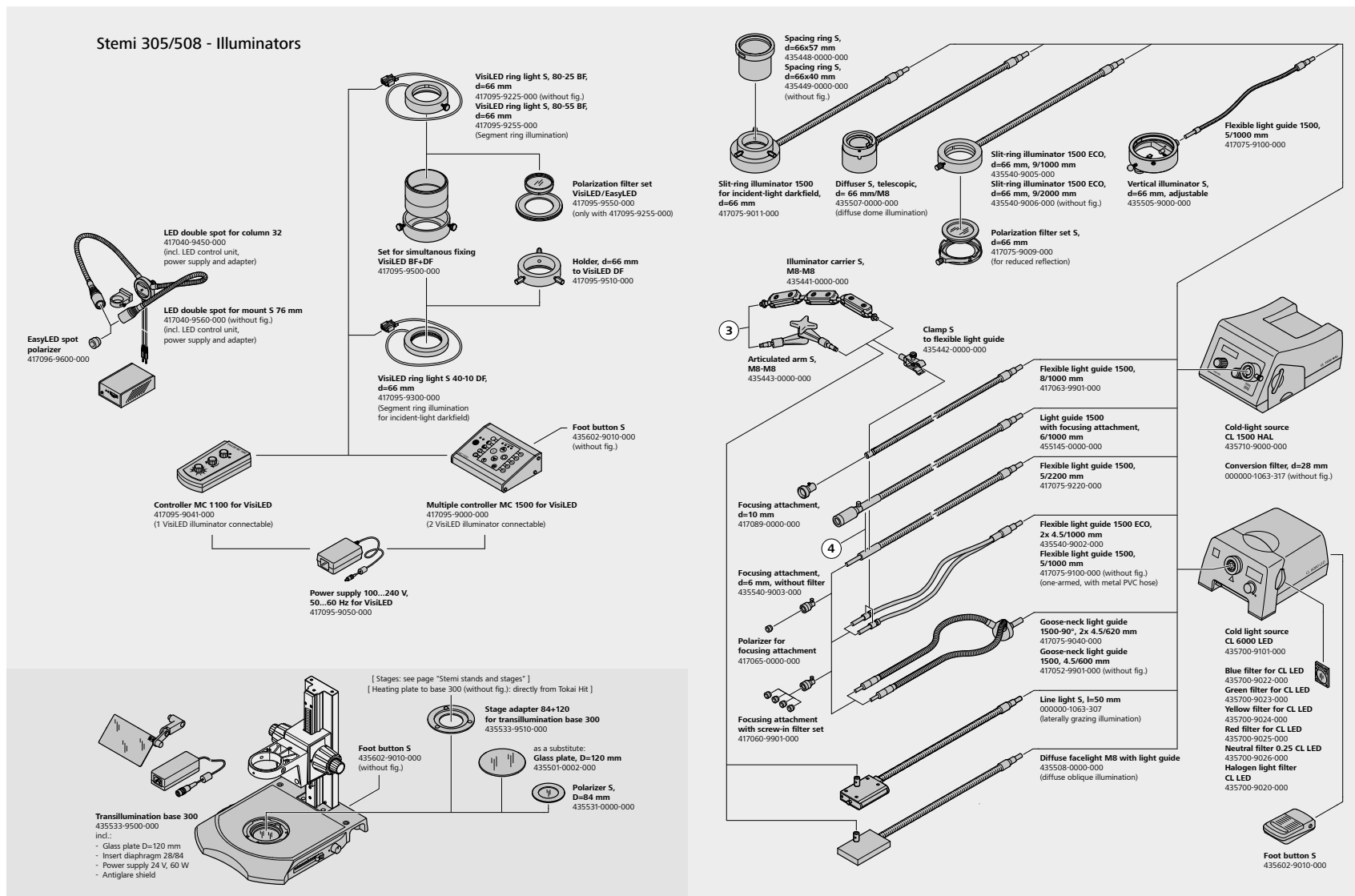

Technical Specifications

- › In Brief
- › The Advantages
- › The Applications
- › The System
- › **Technology and Details**
- › Service

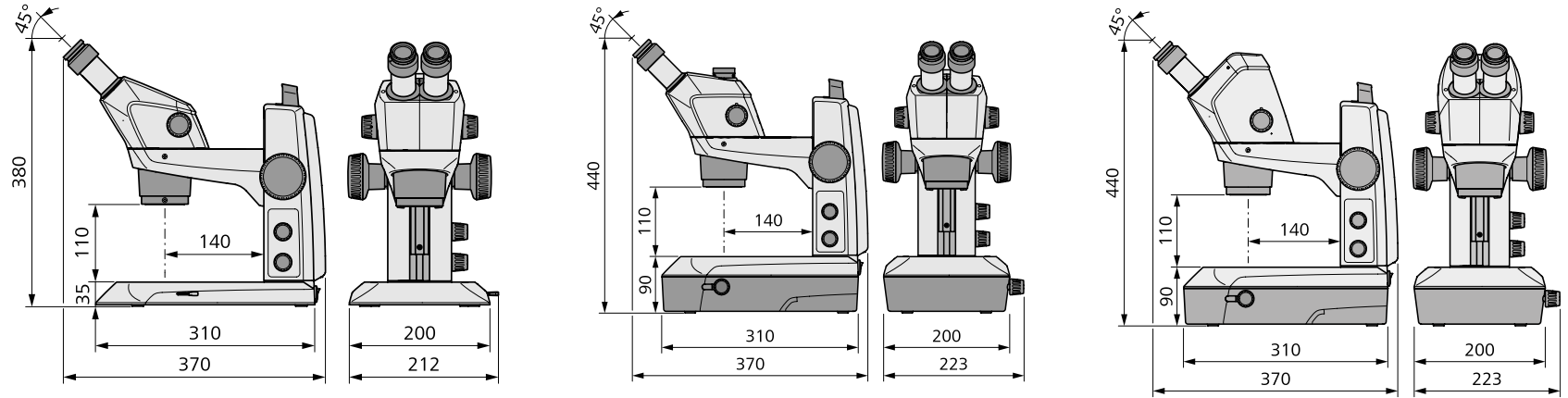

ZEISS Stemi 305		PL 10×23 Br Foc				PL 16×14 Br Foc				PL 25×10 Foc			
Front Optics	FWD	Total Magnification		Object Field [mm]		Total Magnification		Object Field [mm]		Total Magnification		Object Field [mm]	
		Min. Zoom	Max. Zoom			Min. Zoom	Max. Zoom			Min. Zoom	Max. Zoom		
0.5	185	4	20	57.5	11.5	6.4	32	35	7.0	10	50	25.0	5.0
0.75	128	6	30	38.3	7.7	9.6	48	23.3	4.7	15	75	16.7	3.3
1× (without FO)	110	8	40	28.8	5.8	12.8	64	17.5	3.5	20	100	12.5	2.5
1.5	56	12	60	19.2	3.8	19.2	96	11.7	2.3	30	150	8.3	1.7
2.0	43	16	80	14.4	2.9	25.6	128	8.8	1.8	40	200	6.3	1.3

Technical Specifications

- › In Brief
- › The Advantages
- › The Applications
- › The System
- › **Technology and Details**
- › Service

Overall	
Type of Microscope	Stereo microscope, Greenough design
Design Principle	Two zoom systems, tilted by the stereo angle
Stereoscopic View	Three-dimensional observation through eyepieces
Optical Data Basic System (Eyepieces 10×, No Front Optics)	
Magnification Range	8× – 40×
Free Working Distance	110 mm
Maximum Resolution	200 Lp/mm – 2.5 μm
Maximum Object Field Diameter	29 mm
Optical Data with Interchangeable Optics (Eyepieces, Front Optics)	
Accessible Magnification Range	4× – 200×
Free Working Distances	43 – 185 mm
Maximum Resolution	400 Lp/mm – 1.25 μm
Maximum Object Field Diameter	58 mm
Microscope Bodies	
Manual Zoom, Zoom Range	5:1 (0.8× - 4.0×)
Quality of Zoom Optics	Low distortion, crisp in contrast
Parfocality of Zoom Optics	Object remains focused while zooming
Viewing Angle	45°
Adjustment of Interocular Distance	55 - 75 mm
Zoom Click Stops	Five positions: 0.8x, 1x, 2x, 3x, 4x
Maximum Field Number	23 mm
Integrated near Vertical LED Illumination	Integrated in each Stemi 305 microscope body, powered by stands H EDU/LAB/MAT or controller K LED, illumination angle 10° towards optical axis
Documentation Features Stemi 305 trino	Photoport with 50/50 split to the left, integrated camera adapter 0.5×, c-mount interface
Documentation Features Stemi 305 cam	Integrated 4 Megapixel Wi-Fi/Ethernet camera, wireless or wired transmission of image signal*
(*For Stemi 305 cam W body, please ask your local contact for approval in your country. For Stemi 305 cam E body, it can be sold worldwide.)	
Interfaces	
Front Optics and Polarization Analyzer	M52
Eyepieces	d = 30 mm
Stemi Mounts	d = 76 mm
Illuminators	d = 66 mm
Each Microscope Body incl. Eyepieces 10×/23 Br. Foc and Spiral Cable RJ12	

Technical Specifications

- › In Brief
- › The Advantages
- › The Applications
- › The System
- › **Technology and Details**
- › Service

Compact Stand K system:

Stand K	Mechanical stand for external fiberoptic illumination. With 2x M8 interface for light guide carriers. Central through-hole d = 40 mm
Stand K MAT	With interfaces/controls for reflected light illuminators K LED. Provides ESD features (antistatic surface resistance). Central through-hole d = 40 mm
Stand K EDU	With interfaces/controls for reflected light illuminators K LED and built-in flat transilluminator (brightfield / darkfield).
Stand K LAB	With interfaces/controls for reflected light illuminators K LED and built-in mirror based transillumination unit (brightfield / darkfield / oblique).
All stands incl. glass plate and/or BW plastic Plate D = 84x5 mm and dust cover. Stands K EDU/LAB/MAT incl country specific power cable Euro C8	

Stand Base W200xD310xH35 mm (K Lab: H90 mm):

Working Surface	W160xD195 mm
Mechanical Interfaces	Interface for stages d = 84 mm. Interface for TL Polarizer d = 45 mm.

Stand Column with Stemi Mount, Handle and Focus Drive (Friction adjustable):

Height / Lifting range	250 mm / 145 mm
Load capacity of Stemi mount	5 kg
Mechanical Interfaces	Interface for Stemi body d = 76 mm. Interface for Spot / Double Spot K LED

Electronic features of stands K EDU/LAB/MAT:

On/off Switch. Separate control knobs for reflected and transmitted light (push: on/off, rotate: dimming).

Integrated desktop power supply, easily changeable: 12V DC 24W/100...240V AC/50...60Hz. With CE marking, UL, FCC and PSE approved

Optical specifications LED Illuminators K/M (for Stands M LED, Stands K EDU/MAT/LAB)

Color Temperature CCT [K]	Typ. 5600 K
Lifetime (Lumen Maintenance) [h]	Typ. 25000 h (operation time until the light intensity degraded to 70 % of initial value)
LED Spot K, max. brightness	Typ. 30000 lx (object field center, LED spot mounted to stand K EDU)
LED Double Spot K, max. brightness	Typ. 90000 lx (object field center, double spot mounted to stand K LAB)
Segmentable Ringlight K, max. brightness	Typ. 55000 lx (mounted to Stemi 508 body, object focused)
Transilluminator BF/DF M, max. brightness	Typ. 20000 lx (also true for transillumination base of stand K EDU)
Transillumination unit M, max. brightness	Typ. 25000 lx (also true for mirror transillumination base of stand K LAB)

Technical Specifications

- › In Brief
- › The Advantages
- › The Applications
- › The System
- › **Technology and Details**
- › Service

Large Desktop stand M system:

Stand M	Mechanical stand for external fiberoptic illumination with 2x M8 interface for light guide carriers.
Stand M LED	Stand with integrated electronics for reflected/transmitted light LED illuminators K/M.
Both stands incl. BW plastic Plate D = 84x5 mm and Dust Cover. Stand M LED also incl glass plate and power cable Euro C8.	

Stand Base W300x D340x H35 mm:

Working Surface	W255x D215 mm
Mechanical Interfaces	Interface for Stages d = 84 mm. Interface to retrofit Transillumination unit M or flat Transilluminator brightfield/darfield M. Interface for transmitted light polarizer d = 45 mm. Central through-hole 40 mm.

Stand Column with Stemi Mount and Focus Drive (Friction adjustable):

Height / Lifting range	360 mm / 190 mm
Load capacity of Stemi mount	5 kg
Mechanical Interfaces	Interface for Stemi body d = 76 mm. Interface for Spot / Double Spot K LED.

Electronic features of Stand M LED:

Two RJ12 sockets to retrofit reflected light illuminators	Single LED Spot K, Double Spot K and/or segmentable ringlight K
Sliding contacts for transmitted light illuminators	Cable-free adaption of LED Transillumination unit M or Transilluminator brightfield/darkfield M
On/off Switch	
Control knob for transmitted light	Push: on/off. Rotate: dimming
Control knob for two reflected light illuminators	Push sequentially: illuminator A → illuminator B → mixed light A+B → off. Rotate: dimming
Memory section to store three mixed light scenarios	Store and recall "on/off and brightness" of all adapted illuminators K/M (despite "segment settings" of ringlight K)
Integrated desktop power supply unit	12V DC 24W/100...240V AC/50...60Hz. With CE marking. UL, FCC and PSE approved. - Mounted behind focus column, easily changeable.

LED Illuminators for Stands M LED (optical specs see previous page)

LED Spot K	Height adjustable, tiltable, zoomable
LED Double Spot K	Height adjustable. Flexible positioning due to self carrying goosenecks.
Segmentable Ringlight K	Full/half/quarter circle, two opposing quarters. Segments rotatable in steps or continuous movement. Working distance typ 50 mm – 300 mm.
Flat Transilluminator M LED	Flat unit that doesn't add height to the stand. Quick switching between diffuse brightfield and all-sided darkfield.
Transillumination unit M LED:	Variable contrasting by rotatable and slidable mirror: Diffuse and crisp brightfield, oblique and one-sided darkfield illumination. Pol contrast optional

Technical Specifications

- › In Brief
- › The Advantages
- › The Applications
- › The System
- › **Technology and Details**
- › Service

Stands N

Large Stand Base	W440 × D370
Column Height/Diameter	350 or 450 mm/d = 32 mm
Interface for Stages	d = 84 mm
Incl. Black/White Plate D = 84 and Security Ring	
Additionally Needed: Stemi Mount for Column 32 with Drive	
Stages for Interface d = 84 mm	
Gliding stage ±20 mm, rotatable, d = 84 mm	
Ball-and-socket stage ±30°, rotatable, d = 84 mm	
Rotating polarization stage for stereo microscopes, with interfaces for polarizer and lambda plate	

Boom Stands

Single Arm Boom Stand B

Stand base B 32 (dimensions, weight)	W280 mm × D200 mm × H47 mm, ~ 20.5 kg
Vertical column 32/650 mm (length/diameter)	650 mm / d = 32 mm
Horizontal column 32/450 mm (length/diameter)	450 mm / d = 32 mm
Mounting set Boom Stand B 32, consisting of:	Cross piece, adapter BMS, tilting head B 32 and safety ring
Stemi mount for column 32 with drive	With interface d = 76 mm for Stemi body. Lifting range 50 mm. Maximum load 5 kg. Focus drive with adjustable friction

Double Arm Boom Stand SDA

Stand base SDA (dimensions / weight)	W350×D350×H50 mm / ~ 30 kg
Twin Boom SDA: vertical column (length)	610 mm
horizontal double arm, ball-bearing (length)	670 mm
tilting head (column height / diameter)	200 mm / d = 32 mm
Stemi mount for column 32 with drive	With interface d = 76 mm for Stemi body. Lifting range 50 mm. Maximum load 5 kg. Focus drive with adjustable friction

Tilting Arm Stand U with Articulated Suspension Arm

Stand U: table attachment device with column (height)	210 mm
table clamp (for table thickness ...)	5 mm to 75 mm
suspension arm (boom length / lifting range / load)	580 mm / 450 mm / max. 4.8 kg
console for cold light source	e.g. CL6000 LED, CL9000 LED, CL1500 Hal
adapter for tilting head B 32	

Traverse U (optional)	W320 × H60 mm, column diameter 32 mm, length 115 mm
------------------------------	---

Tilting head B 32/115 (mandatory)	
--	--

Stemi mount for column 32 with drive (mandatory)	With interface d = 76 mm for Stemi body. Lifting range 50 mm. Maximum load 5 kg. Focus drive with adjustable friction
---	---

Technical Specifications

- › In Brief
- › The Advantages
- › The Applications
- › The System
- › **Technology and Details**
- › Service

Floor Stand S with Articulated Suspension Arm

Floor stand S:	Stand base, with four lockable wheels	W625 × D625 mm
	Stand column (height above floor)	~ 1730 mm
	Traverse (boom length)	500 mm
	Console for cold light source	
	Suspension arm (boom length / lifting range / height / load)	600 mm / 650 mm / max. 1880 mm above floor / max. 7 kg
	Tilting head with adapter to suspension arm	
Stemi mount for column 32 with drive (order separately)	With interface d = 76 mm for Stemi body. Lifting range 50 mm. Maximum load 5 kg. Focus drive with adjustable friction	

Fiberoptic Illuminations

Cold Light Source CL 6000 LED

Light Engine	High power LED engine
Light Flux (output of ringlight, fiber bundle diam. 9 mm)	Max. 600 lm
Color Temperature	Typ. 6200 K. (Optional accessories: Daylight filter for a CCT of typ. 5600 K respectively Halogen Light filter for a CCT of typ. 3200 K)
Color Rendering Index	~ 80
LED Lifetime (Lumen Maintenance)	typ 50.000 h (operation time until the light intensity degrades to 70 % of initial value)
Light Guide Sensor	"Auto off" if no light guide is inserted
3 Pos. Filter Slider	For two filters (in filter holder) plus free opening
Wide-range Supply	100 – 240 V ± 10 %, 50 – 60 Hz, max. 50 W – open frame unit, integrated in the light source
Flicker free light, silent axial fan, 2.5 mm phone socket for foot button S	

Cold Light Source CL 1500 HAL

Light Engine	150 W halogen reflector lamp
Light Flux (output of ringlight, fiber bundle diam. 9 mm)	Max. 600 lm at 100 % dimming / ~ 450 lm at 80 % dimming
LCD Display	Displays brightness level / color temperature / power-on hours
Bulb Lifetime at dimming level 50 / 80 / 100 %	Typ 1500 h / 150 h / 50 h
2 Pos. Filter Slider	For one filter (d = 28 mm without filter holder) plus free opening
Wide-range Supply For Flicker Free Light, Silent Axial Fan	100 – 240 V ~ 50 – 60 Hz, max. 180 W – open frame unit, integrated in the light source

Technical Specifications

- › In Brief
- › The Advantages
- › The Applications
- › The System
- › **Technology and Details**
- › Service

Light Guides

Single and double spot flexible light guides	Flexibel sheathing. For oblique light; crisp 3d impression by distinct shadows. Precise positioning via supporting arms (order separately).
Single and double spot gooseneck light guides	Self supporting. For oblique light; crisp 3d impression by distinct shadows
Annular ring illuminators D = 66 mm for Brightfield	Shadow free illumination
Annular ring illuminators D = 66 mm for Darkfield	Shadow free illumination. Gliding stage recommended.
Line light 50 mm	Homogeneous grazing light to emphasis structures of flat surfaces. Positioning via supporting arm (order separately). Gliding stage recommended.
Vertical illuminator	For illumination of deepenings and holes. Needs supporting flexible spot light guide.
Diffusor S	Shadow free all sided soft light, "cloudy day illuminator"; to avoid glare. Ball-and-socket stage recommended.
Diffuse area light	One sided "soft" illumination; to avoid glare but also create certain shadows. Positioning via supporting arm (order separately).

Illumination Accessories

Focusing optics for spot light guides	Increase brightness
Polarizing equipment for spots and ringlights	Reduce reflections

Ambient Conditions

Storage (in Packaging)

Permissible Ambient Temperature	+10 to +40 °C
Permissible Humidity	Max. 75 % to +35 °C (without condensation)

Transportation (in Packaging)

Permissible Ambient Temperature	-40 to +70 °C
---------------------------------	---------------

Operation

Permissible Ambient Temperature	+10 to +40 °C
Permissible Humidity	Max. 75 %
Air Pressure	800 hPa to 1060 hPa
Degree of Pollution	2
Area of Use	Closed spaces
Max. Altitude	Max. 2000 m

Operational Data – Power Supply unit for stand M LED, stands K EDU/LAB/MAT and Controller K LED

Protection Class	II
Protection Type	IP 20
Electrical Safety	Acc. to DIN EN 61010-1 (IEC 61010-1)
Degree of Pollution	2
Overtoltage Category	2
Power Supply	100 to 240 V ±10 %
Converting the line voltage is not necessary!	
Power Frequency	50 Hz / 60 Hz
Power Consumption: Stage Power Supply with Microscope	Max. 40 VA
Output Power Supply Microscope and Controller K LED	12 V DC, max. 2 A
Input Output Power Supply Microscope and Controller K LED	100 to 240 V, 50 / 60 Hz, max. 1.5 A

ZEISS Service – Your Partner at All Times

Your microscope system from ZEISS is one of your most important tools. For over 175 years, the ZEISS brand and our experience have stood for reliable equipment with a long life in the field of microscopy. You can count on superior service and support - before and after installation. Our skilled ZEISS service team makes sure that your microscope is always ready for use.

- › In Brief
- › The Advantages
- › The Applications
- › The System
- › Technology and Details
- › **Service**

Procurement

- Lab Planning & Construction Site Management
- Site Inspection & Environmental Analysis
- GMP-Qualification IQ/OQ
- Installation & Handover
- IT Integration Support
- Startup Training

Operation

- Predictive Service Remote Monitoring
- Inspection & Preventive Maintenance
 - Software Maintenance Agreements
 - Operation & Application Training
 - Expert Phone & Remote Support
 - Protect Service Agreements
 - Metrological Calibration
 - Instrument Relocation
 - Consumables
 - Repairs

New Investment

- Decommissioning
- Trade In

Retrofit

- Customized Engineering
 - Upgrades & Modernization
- Customized Workflows via ZEISS arivis Cloud



Please note: Availability of services depends on product line and location

>> www.zeiss.com/microservice



Carl Zeiss Microscopy GmbH
07745 Jena, Germany
microscopy@zeiss.com
www.zeiss.com/stemi305

Follow us on social media:



Not all products are available in every country. Use of products for medical diagnostic, therapeutic or treatment purposes may be limited by local regulations.
Contact your local ZEISS representative for more information.
EN_40_011_089 | Version 2.0 | CZ 05-2024 | Design, scope of delivery, and technical progress subject to change without notice. | © Carl Zeiss Microscopy GmbH